

# Cincom

## M32

Sliding Headstock Type CNC Automatic Lathe

# CITIZEN



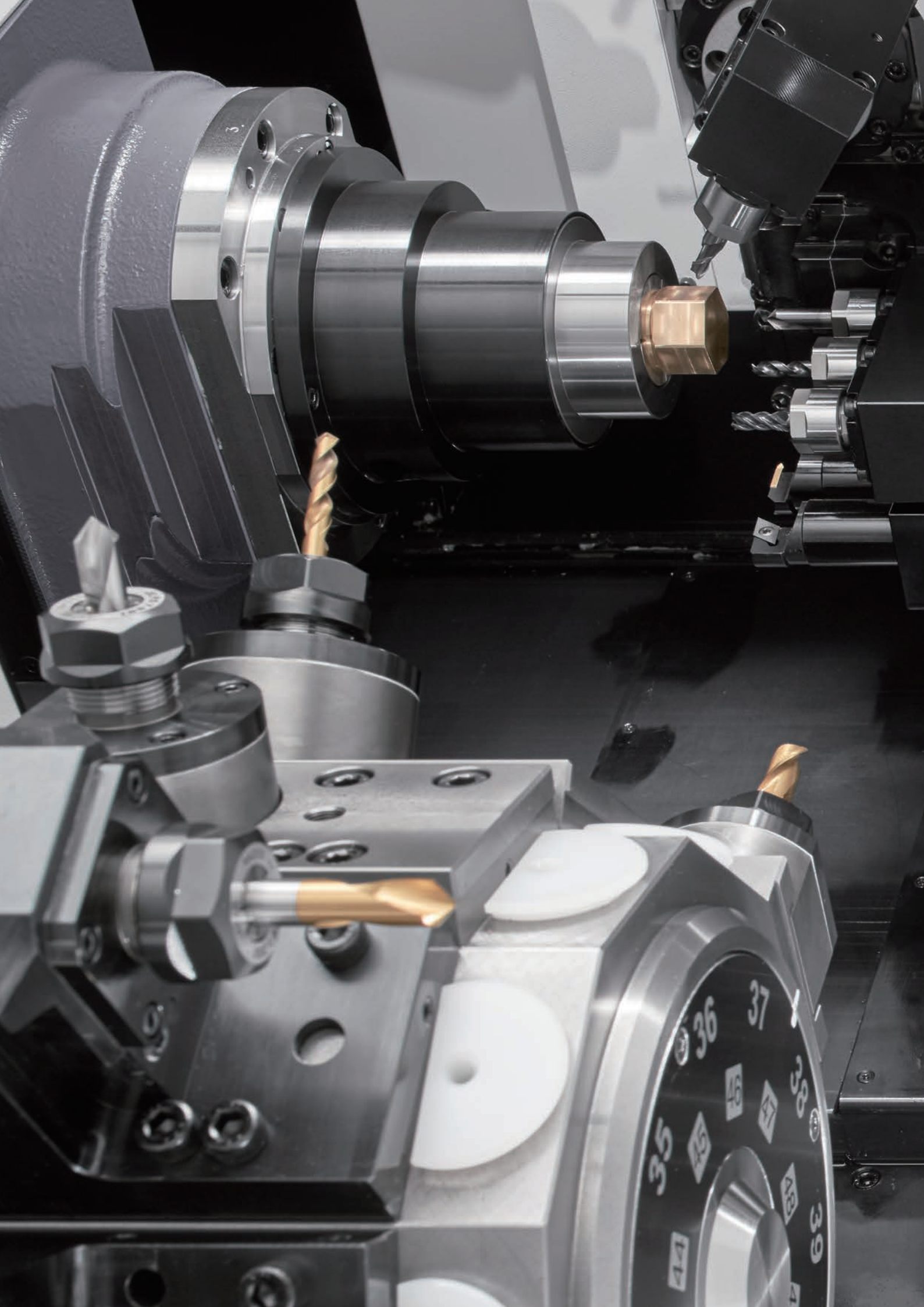

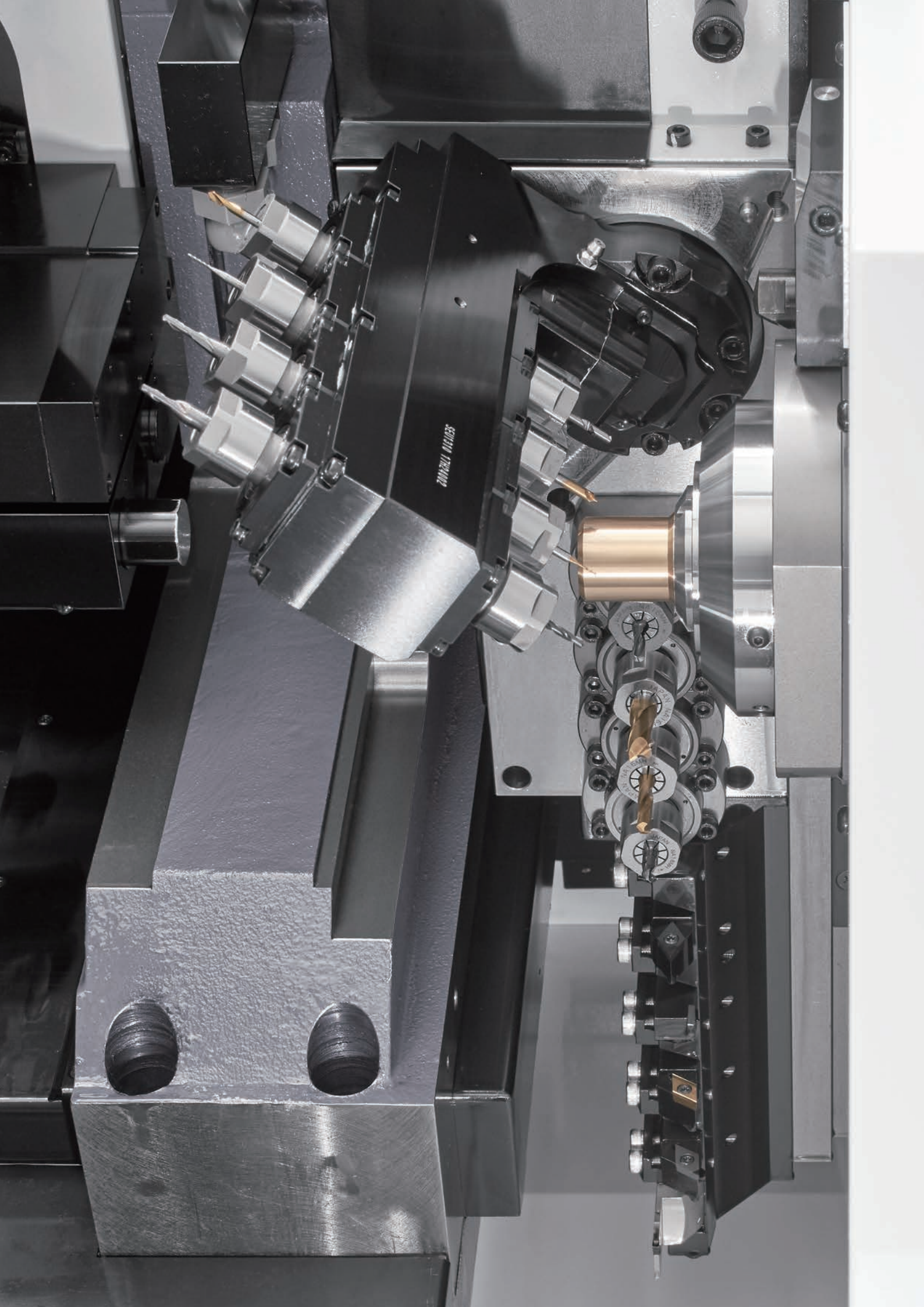



M32-VIII

## Ultimate Gang + Turret: The M32 is Reborn

While inheriting the basic configuration of “gang tool post + turret”, the new M32 has pursued the optimal balance of strength and weight through structural analysis, and greatly improves the rigidity that is the cornerstone of machining.

In addition, a single drive mechanism is introduced for rotary tools on the turret tool post, together with updated tooling. The rotary tool drive motor on each tool post has also been enhanced.

5.5/7.5 kW high-power spindle motors are adopted for both front and back spindles, achieving powerful machining and high acceleration/deceleration.

The gang tool post features a B-axis spindle (Type VIII) that supports contouring through 5-axis control.

The back tool post is equipped with an adjustable angular spindle (Type VII/VIII) for more complex machining in combination with the Y axis. Enhanced back machining capability is also increased due to the flexibility of the machining process.

In addition, a 38mm oversized specification option is available, and it is possible to switch between guide bush and guide bushless operation.



# Basic Structure

The image shows the type VIII

## Rear tool post

Type V: 5 stations  
 Type VII: Max. of 9 stations (including 3 adjustable angle tools)  
 Type VIII: Max. of 9 stations (including 3 adjustable angle tools)

## Main spindle

Main spindle speed: 8,000 min<sup>-1</sup>  
 Motor: 5.5/7.5 kW  
 Max. machining length: 320 mm/1  
 chucking (GB)

## Opposed spindle

Main spindle speed: 8,000 min<sup>-1</sup>  
 Motor: 5.5/7.5 kW

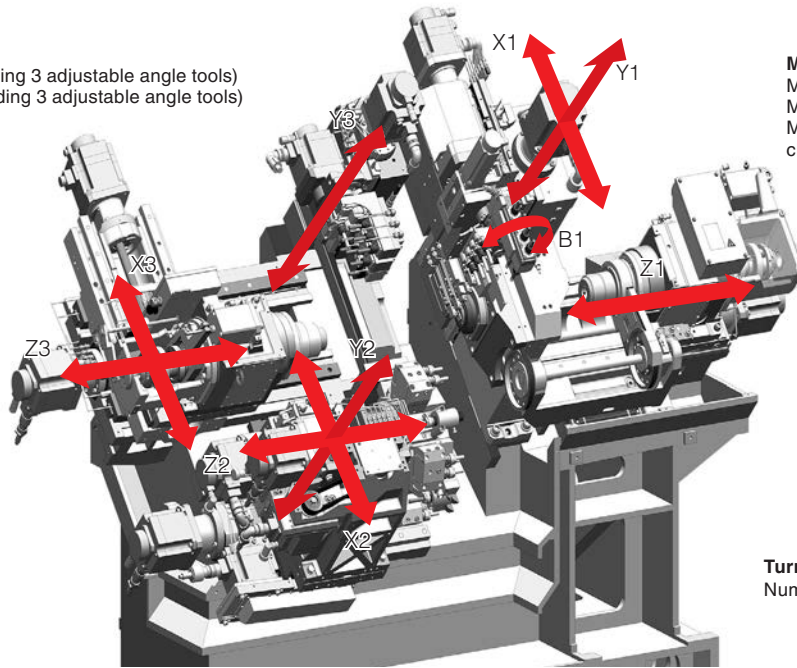

## Turret tool post

Number of turret stations: 10

Machine configuration by type

Type	V	VII	VIII
B axis (gang rotary tools)	---	---	●
Y3 axis (back tool post Y axis)	---	●	●
Driven tool capability on rear tool post	---	●	●
Total number of tools	25to36+ $\alpha$	23to40+ $\alpha$	30to36+ $\alpha$

## Gang tool post

Type V Turning tools: 5  
 Cross drilling tools: 5 to 7  
 Type VII Turning tools: 5  
 Cross drilling tools: 5 to 7  
 Type VIII Turning tools: 5  
 Cross drilling tools: 8 (of which B-axis tools: 4)  
 Back face drilling tools: 4 (of which B-axis tools: 4)

# LFV Function (Optional)



LFV (low-frequency vibration cutting) is a technology for performing machining whilst oscillating the X and Z servo axes in the cutting direction in synchronisation with the rotation of the spindle. It reduces all problems caused by swarf entangling with the component or tool, and is effective for small-diameter deep hole machining and the machining of difficult to chip materials.W

	LFV mode 1	LFV mode 2	LFV mode 3
Operation	Multiple vibrations per spindle revolution	Multiple spindle revolutions per vibration	Vibration threading
Specification	The axes execute multiple vibrations during one spindle revolution, reliably breaking chips up into small pieces.	Machining is carried out while rotating the spindle multiple revolutions per vibration.	A vibrating behavior is applied in the direction of the cutting (notching) during threading with the timing of this vibration changing with each pass in relation to the rotary phase of the spindle to provide "air-cutting" during the machining and break up chips.
Application	Ideal for outer/inner diameter machining and groove machining	Ideal for micro-drilling, where peripheral speed is required	Optimal for threading of internal and external diameters
Waveform			

Model	Front side LFV	Back side LFV	LFV mode 1	LFV mode 2	LFV mode 3
V			✓	✓	✓
VII	X1, Z1	X3, Z3	✓	✓	✓
VIII			✓	✓	✓

# B-axis machining for more complex shapes, back face inclined machining

The gang tool post features a fully programmable B axis (back face 45°, front face 105°)<sup>(Type VII)</sup>. The rear tool post has been equipped with a 3 tool adjustable angle spindle <sup>(type VII and VIII)</sup> to provide even more complex machining. Equipped with a Y-axis on the rear tool post and a B-axis on the gang tool post enabling complex machining, whilst extending the range of machining operations on the back spindle. This creates a higher degree of flexibility in the allocation of machining processes, which tended to be biased toward the front spindle, increasing productivity.

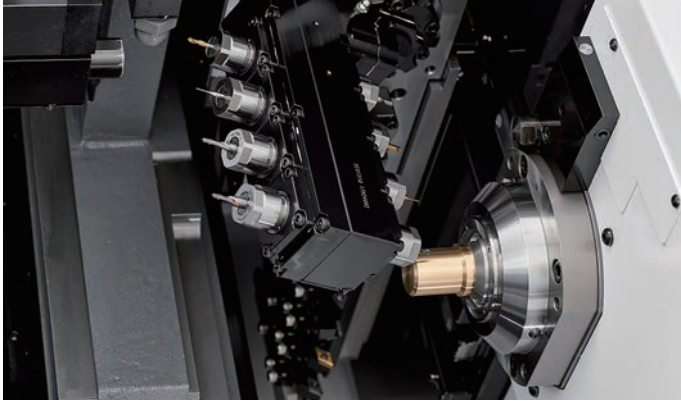

B axis: rotary tools on the gang tool post

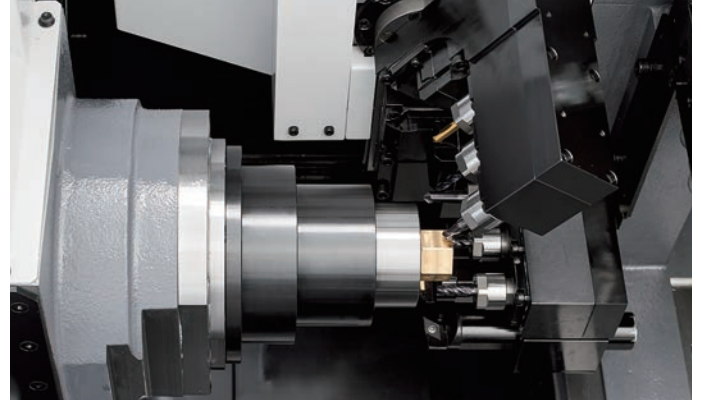

3 tool adjustable angle spindle

## New turret adopting single tool 'direct' drive

Utilised for the first time by Cincom, a single drive mechanism whereby only the selected rotary tool rotates. Elimination of wasted rotation of non-selected tools enables powerful machining with high accuracy while suppressing heat generation, vibration and loss of power. It also extends the lives of gears and bearings, and reduces running costs. Furthermore, the increased rigidity of the internal gears and bearings enables high-torque transmission. An improved motor with high torque of 2.2 kW/22 Nm, (which is more than twice the torque of the previous M32 models), for driving rotary tools on the turret tool post.

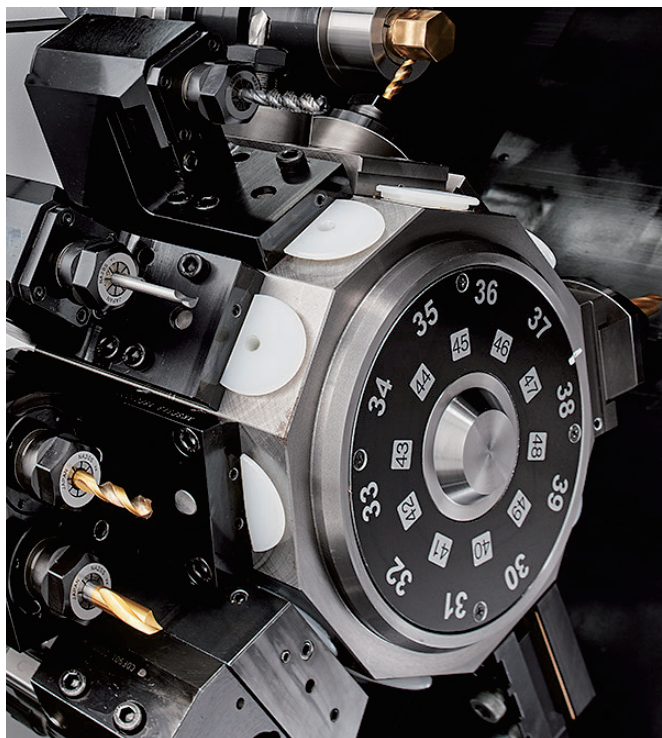

## Switchable between guide bush and guide bushless operation

When machining long thin workpieces, the machine is used as a guide bush type. When producing less than two and half times diameter components, it can be used in guide bushless mode. The benefits are shorter bar remnants and ability to use bar stock with variable diameter tolerance.

Guide bushless mode

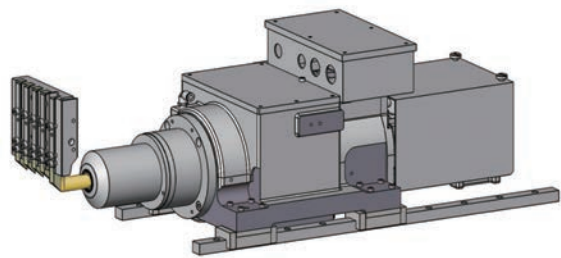

Guide bush mode

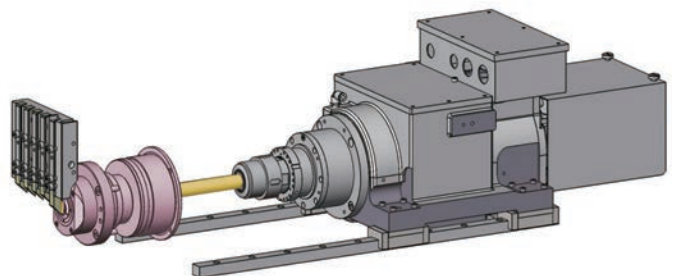

## Double speed rotary tool

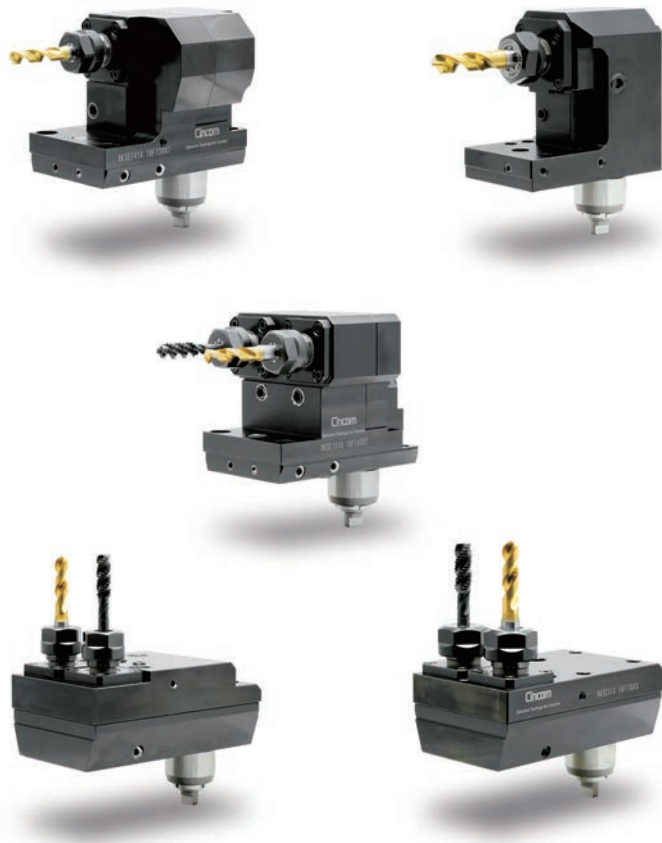

For rotary tools on the turret, high-speed models of end face drilling spindles and cross-drilling spindles are available. The maximum spindle speed has been increased to 12,000 min<sup>-1</sup>, supporting machining with small-diameter tools.

Rotary tools on the turret tool post Torque diagram

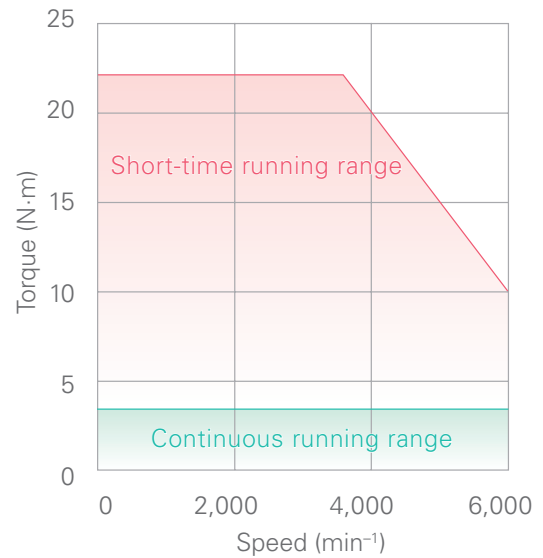

## Working efficiency improved



Operator access has been increased to 165% of the size of previous M model machines, giving increased space for more efficient tool setting. By also expanding the size of the window, visibility when the door is closed is improved.

# Control panel with new HMI (human machine interface)



The control panel featuring the new HMI (human machine interface) is equipped with a 15-inch touch screen, improving machine operating convenience for the operator. In addition, the universal design concept is applied to the colour scheme of the control panel for the first time. It considers the fact that colours may appear different to different people and makes the information easy to see and understand for everyone.



\* Certification has been acquired from the Media Universal Design Association (MUD Association).

## NC Functions

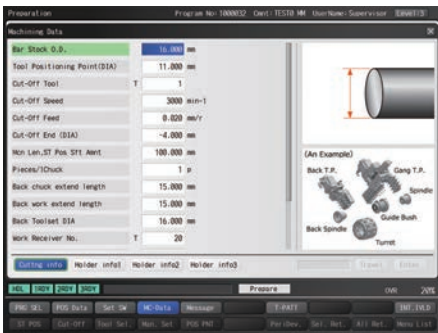

### Machining data screen

In response to the selection of an item, the corresponding illustration is displayed on the screen so that the operator can easily recognise the meaning of the selected item.



### Tool selection screen

The selected tool moves to the waiting point.

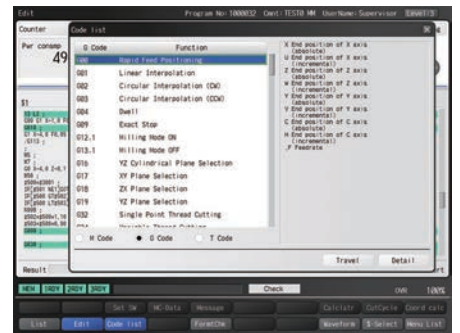

### Code list

The function displays the list of G and M codes including explanations of the arguments to support programming.

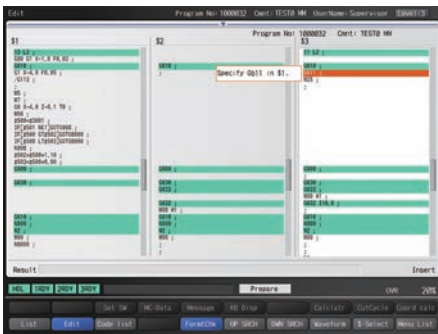

### Format check

On the Edit screen, the operator can check whether there are any syntax errors in the program before running it.



### High-speed program check

Programs can be checked at high speed without operating the machine (machine lock status).



### On-machine program check

This runs the machining program at high speed without operating the machine and detects program errors. It also allows you to measure the approximate cycle time.

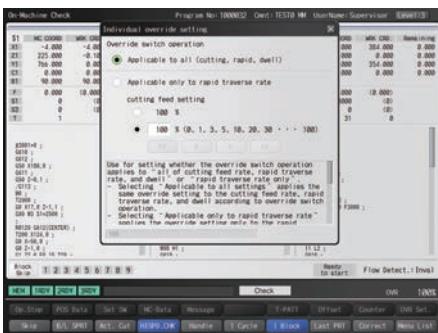

### Rapid feed override

It is also possible to control only the rapid feed rate in accordance with the setting of the dial while fixing the override for the cutting feed rate.



### Turret tool post setting

On machine tool setting is possible for the turret tool post as well as for the gang tool post.

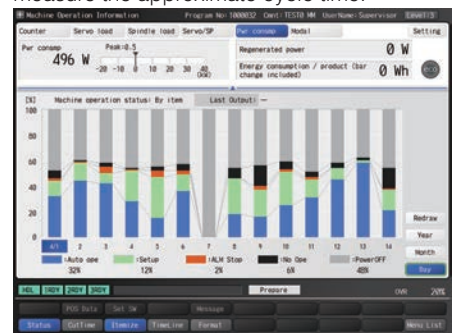

### Machine operating status screen

This screen classifies the operating status as five items - automatic operation time, alarm stop time, setup time, non-operation time, and power OFF time - and displays graphs for each of these items or in a time series.



# Options

## Product Unloader

Installing the product unloader eliminates the time for collection by the turret, shortening cycle times. The product receiver shelf for product unloader is a shelf for receiving unloaded products. Using the product receiver shelf of long workpiece device makes it possible to combine product unloading with a function for ejecting long workpieces from the rear of the back spindle.

Product receiver shelf for product unloader U352J

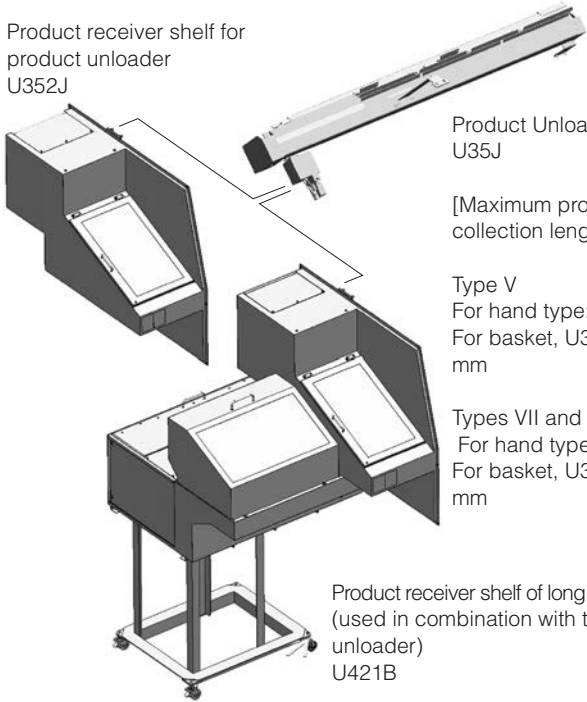

Product Unloader U35J

[Maximum product collection length]

Type V  
For hand type: 225 mm  
For basket, U351J: 110 mm

Types VII and VIII  
For hand type: 195 mm  
For basket, U351J: 110 mm

Product receiver shelf of long workpiece device (used in combination with the product unloader) U421B

## High-pressure coolant device

This contributes to effective chip removal and the improvement of machining accuracy / tool life.



## Chip conveyor

The chip conveyor is used in combination with the U12R extended coolant tank unit.

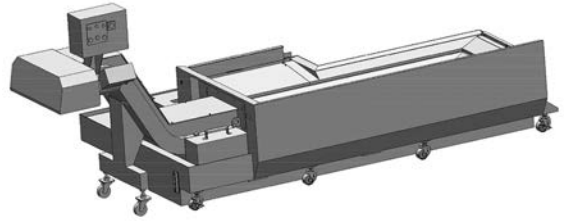

## Extended coolant tank

With a coolant capacity of 295 L, this is used in combination with the chip conveyor/high-pressure coolant unit.

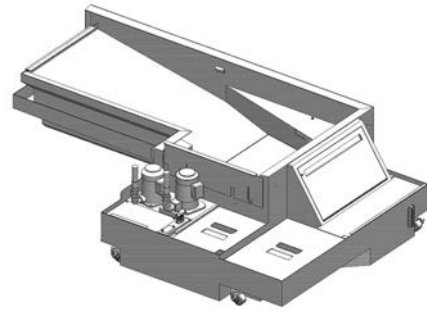

## Workpiece conveyor switchbox

This allows manual operation (selection of continuous running or intermittent running) close to the workpiece ejection port.



## Workpiece conveyor

A workpiece conveyor can be equipped to facilitate the efficient mass production of workpieces. The cover over the unloading route can be opened easily, giving good maintainability too. In addition, periodic cleaning of the chip collector basket, which was required on the existing machine, is no longer necessary due to the improvement of the structure.

## Machine dimensions

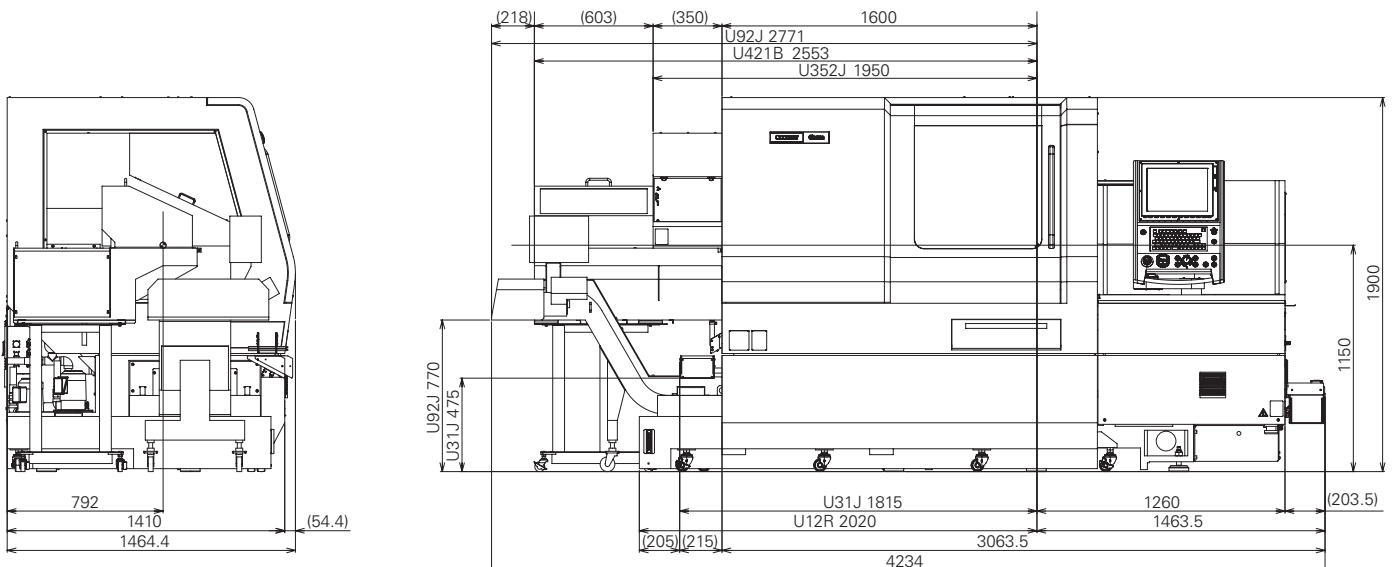

# Tooling system

for Gang tools

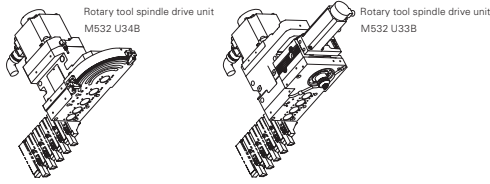

## Tool holder

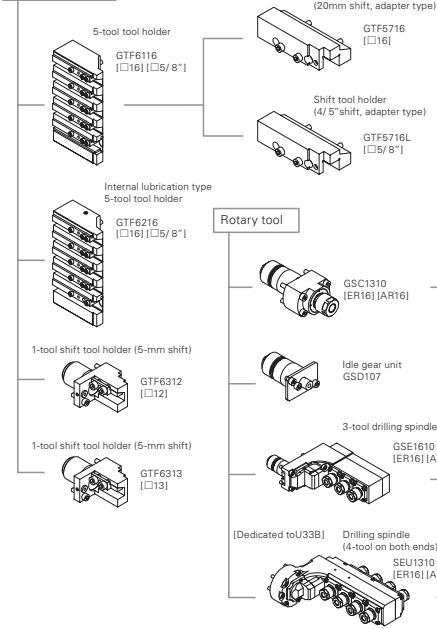

## sleeve holder

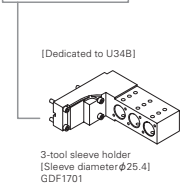

## Sleeve

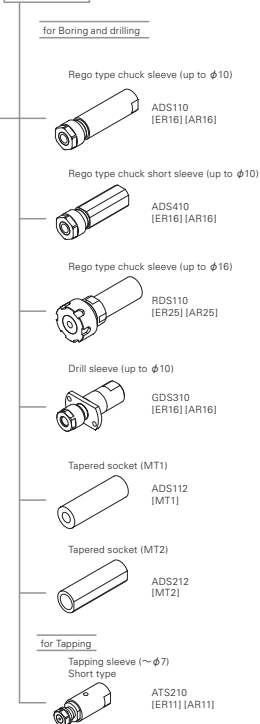

for Turret tool post

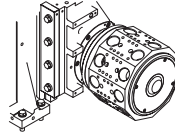

## Tool holder

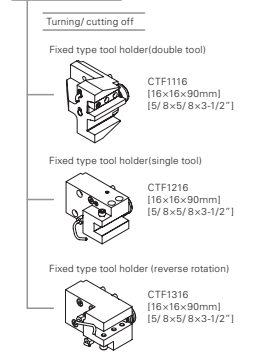

## Sleeve holder

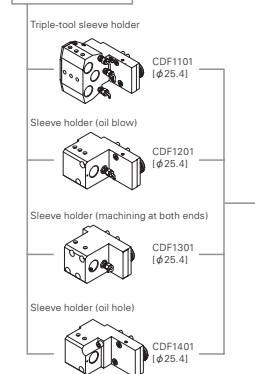

## sleeve

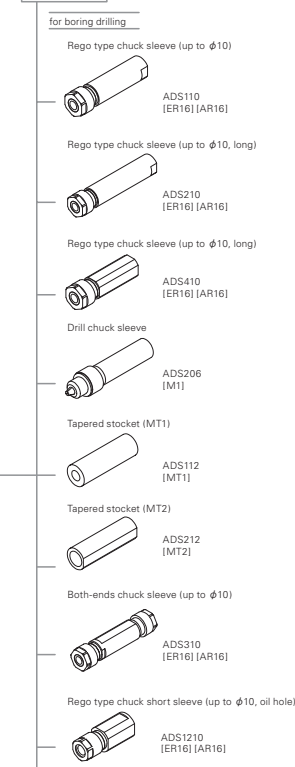

Rego type chuck sleeve (up to φ10, oil hole)

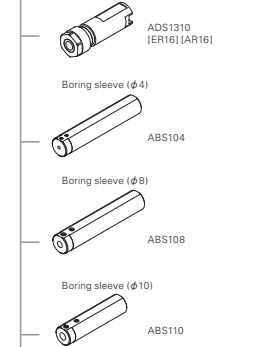

for Tapping and die machining

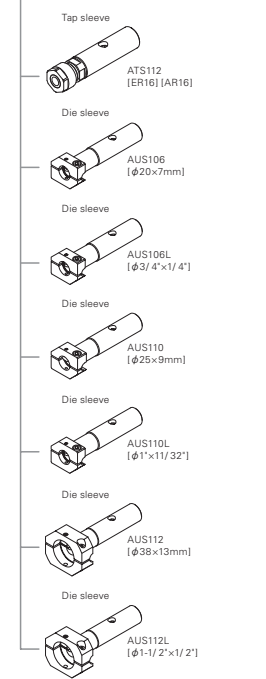

## Rotary tool

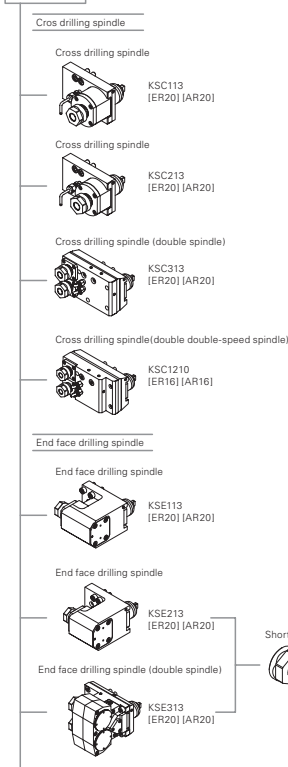

End face drilling spindle (double-speed spindle)

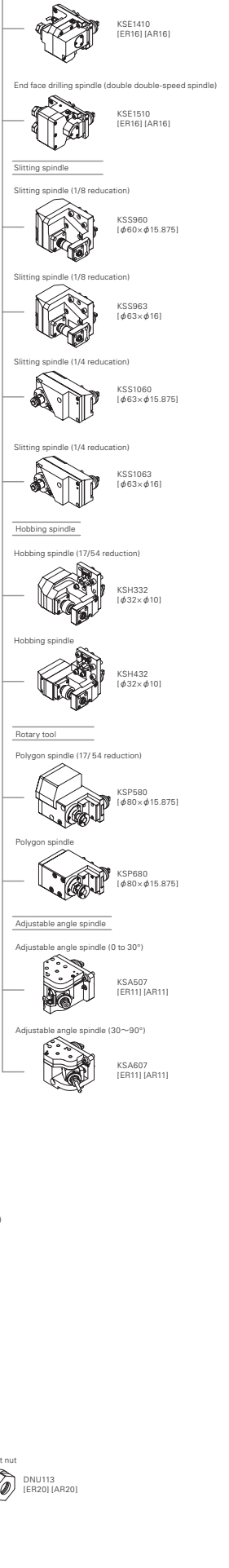

for Back tool post

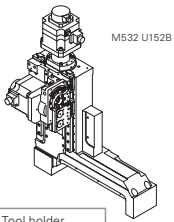

M532 U152B

Tool holder

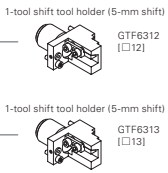

Sleeve holder

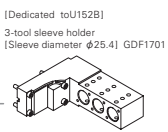

Rotary tool

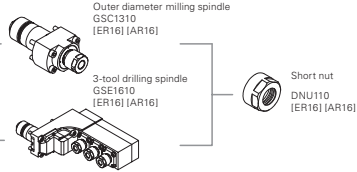

Sleeve

for Boring and drilling

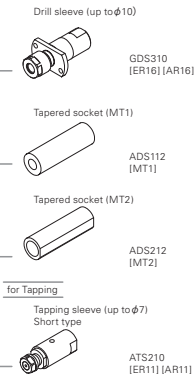
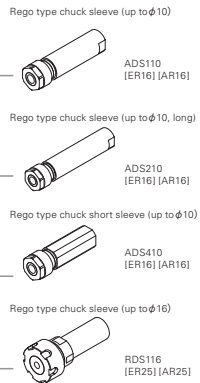

for Back tool post

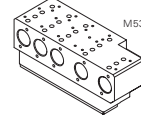

M532 U150B

Sleeve

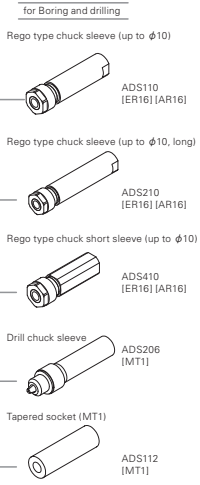

Tapered socket (MT2)

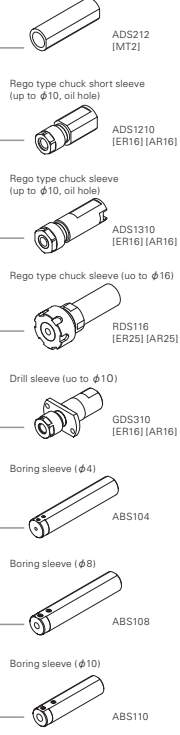

for tapping and die machining

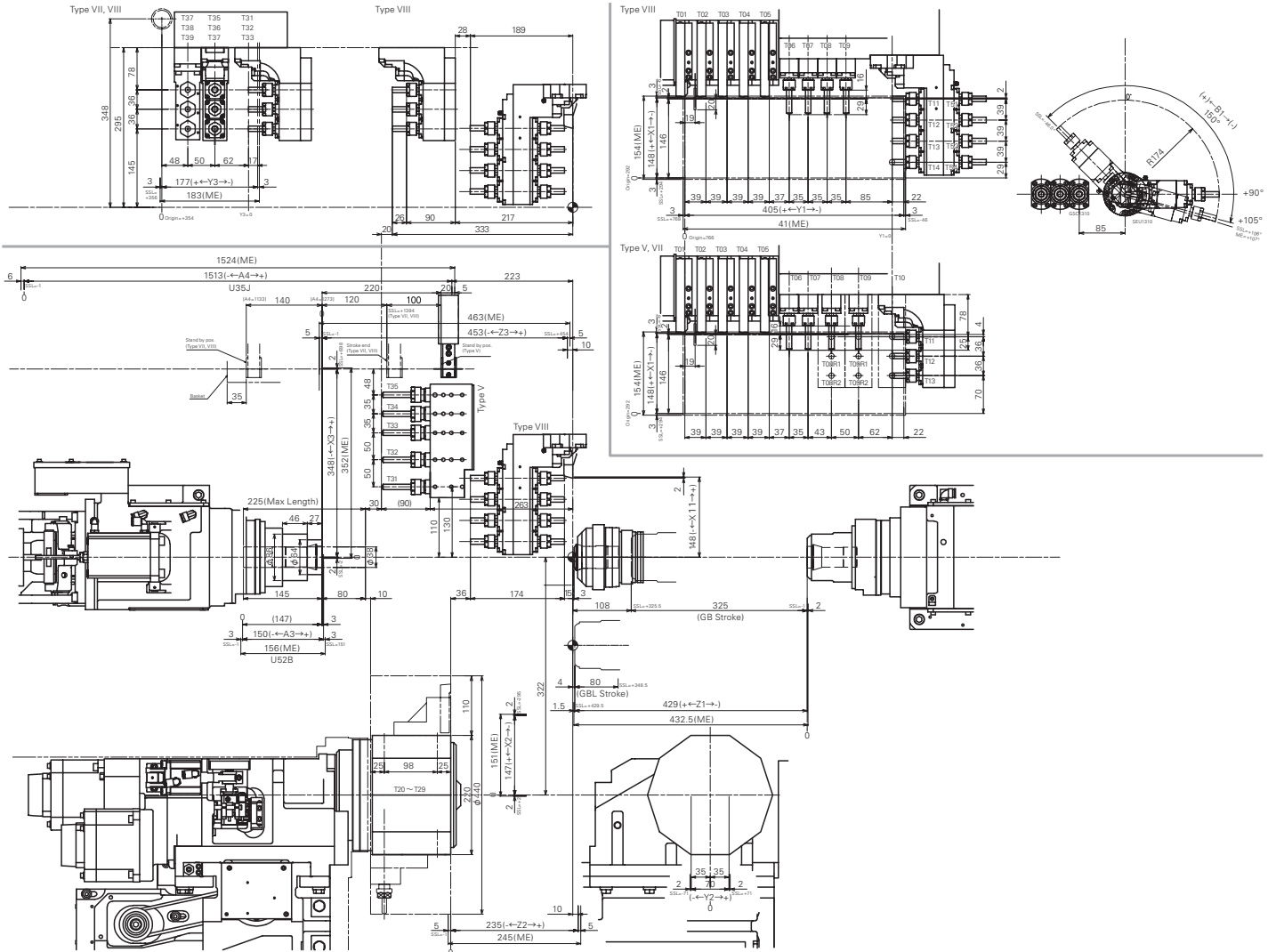
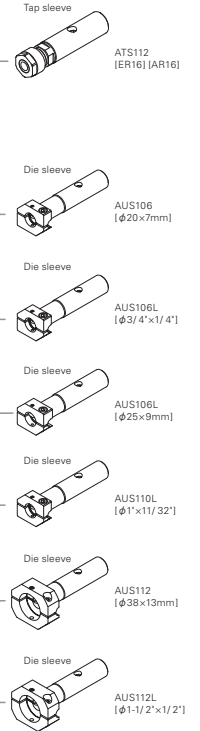

# Machine Specification

Item	M32		
	V	VII	VIII
	M32 - 5M5	M32 - 5M7	M32 - 5M8
Max. machining diameter (D)	32 mm dia. (38 mm <sup>OP</sup> )		
Max. machining length (L)	320 mm/1 chucking		
Max. front drilling diameter	12 mm dia.		
Max. tapping diameter for the front spindle	M12 (Cutting tap)		
Main spindle speed	Max. 8,000 min <sup>-1</sup>		
Max. chuck diameter for the back spindle	32 mm dia. (38 mm <sup>OP</sup> )		
Max. drilling diameter for the back spindle	12 mm dia.		
Max. tapping diameter for the back spindle	M12 (Cutting tap)		
Max. length of the back spindle workpiece	145 mm (Standard recovery unit)		
Back spindle speed	Max. 8,000 min <sup>-1</sup>		
Gang rotary tools			
Max. drilling diameter	8 mm dia.		
Max. tapping diameter	M8 (Cutting tap)		
Main spindle speed	Max. 9,000 min <sup>-1</sup>		
Turret rotary tools			
Max. drilling diameter	12 mm dia.		
Max. tapping diameter	M12 (Cutting tap)		
Main spindle speed	Max. 6,000 min <sup>-1</sup>		
Back rotary tools			
Max. drilling diameter	8 mm dia.		
Max. tapping diameter	M6 (Cutting tap)		
Main spindle speed	Max. 6,000 min <sup>-1</sup>		
Number of tools	25 to 27 + 23 to 31 + 30 to 36 +		
Turning tools	5		
Cross drills	5 to 7		8 (including 4 B-axis drills)
Gang tool post backside drills	Max. 4		4 (including 4 B-axis drills)
Number of turret stations	10		
Back tool post drills	5	Max. 9	
Tool size			
Turning tool	16 mm		
Sleeve diameter	25.4 mm dia.		
Chuck and bushing			
Main spindle collet chuck	FC081-M (FC251-M: 38-mm dia. Opt.)		
Back spindle collet chuck	FC081-M-K (FC251-M-K: 38-mm dia. Opt.)		
Guide bushings	FG531-M and WFG531-M (FG581-M: 38-mm dia. Opt.)		
Rapid feed rate			
X1, Y1, Z1, Z2, X3, Z3	32 m / min		
Y3	---	32 m / min	
X2	18 m / min		
Y2	12 m / min		
B1	-	50 min <sup>-1</sup>	
Motors			
Front spindle drive	5.5 / 7.5 kW		
Back spindle drive	5.5 / 7.5 kW		
Gang rotary tool drive	2.2 kW		
Turret rotary tool drive	2.2 kW		
Back rotary tool drive	1.0 kW		
Pneumatic unit: Required pressure and required flowrate	0.5 MPa at 110 NL/min. (When stationary)		
Machine main unit dimensions	(W) 2,860 × (D) 1,465 × (H) 1,900 mm		
Weight	4,250 kg	4,300 kg	
Power supply voltage	AC200V ± 10%		
Rated power consumption	24 kVA	25 kVA	
Full-load current	79 A		
Main breaker capacity	100 A		

## Main standard accessories

Main spindle chucking unit	Back spindle chucking unit
Gang rotary tool driving unit	Back rotary tool driving unit <sup>*Types VII, VIII</sup>
Rotary guide bushing unit	Knock-out jig for through-hole workpiece
Coolant unit (with level detector)	Lubricating oil supply unit (with level detector)
Motor knock-out device for back machining	Motor-driven workpiece separator
Machine relocation detector	Spindle cooling unit
Door lock	Machine internal lighting
Cut-off tool breakage detector	Coolant flow rate detector
Product unloader	3-colour signal tower

## Special accessories

Chip conveyor	Long workpiece unit
High-pressure coolant unit	Workpiece conveyor
Medium-pressure coolant unit	M32 special tool

## Standard NC functions

CINCOM SYSTEM M830W (Mitsubishi Electric) <sup>*Types V, VII</sup>	CINCOM SYSTEM M850W (Mitsubishi Electric) <sup>*Type VIII</sup>
15-inch XGA touch panel	USB slot
Program storage capacity: 160m (Approx. 64 KB)	Tool offset pairs: 99
Product counter indication (up to 8 digits)	User-opened disk capacity of 10 MB
Preparing operation functions	Operating time display function
Machine operation information display	B-axis control function <sup>*Type VIII</sup>
Back machining program skip function	Obstruction check
Impact detection function	Spindle speed change detector
Constant peripheral speed control function	Automatic power-off function
Spindle 1° indexing function	On-machine program check function
Nose radius compensation	Eco display
Chamfering/Corner R function	Canned cycle for composite turning
Geometric command function	Spindle C-axis function
Spindle synchronised function	Back spindle 1° indexing function
Milling interpolation function	Back spindle chasing function
Back spindle C-axis function	Canned cycle for drilling
Synchronised tapping function	User macros
RS232C connector	

## Optional NC functions

Variable lead thread cutting	Arc threading function
Differential speed rotary tool function	3D chamfering function
Tool life management I	Synchronised tapping phase adjustment function
Program storage capacity: 4800 m (1,920 KB)	High-speed synchronised tapping function
External memory program driving	Optional block skip (9 sets)
Inclined helical interpolation function	Tool life management II
Polygon function	User-opened disk capacity of 100 MB
Helical interpolation function	Submicron commands
Hob function	Inch command
Sub inch command	Network I/O function

# CITIZEN

**CITIZEN MACHINERY CO., LTD.**

**Japan**

Citizen Machinery Co., Ltd.  
4107-6 Miyata, Miyota-machi, Kitasaku-gun, Nagano-ken,  
389-0206, Japan

Tel: 81-267-32-5901

Fax: 81-267-32-5908

**Europe-UK**

Citizen Machinery UK Ltd  
1 Park Avenue, Bushey, WD23 2DA, UK

Tel: 44-1923-691500

Fax: 44-1923-691599

[www.citizenmachinery.co.uk](http://www.citizenmachinery.co.uk)

All specifications are subject to change without prior notice. This product is an export control item subject to the foreign exchange and foreign trade act. Thus, before exporting this product, or taking it overseas, contact your CITIZEN machine dealer. Please inform your CITIZEN machine dealer in advance of your intention to re-sell, export or relocate this product. For the avoidance of doubt products includes whole or part, replica or copy, technologies and software. In the event of export, proof of approval to export by government or regulatory authority must be evidenced to CITIZEN. You can operate the machines after the confirmation of CITIZEN CITIZEN is a registered trademark of Citizen Holdings Co., Japan